

# CP PLUNGER PUMP SERVICE MANUAL



**3CP MODELS:** 3CP1120, 3CP1130, 3CP1140

**5CP MODELS:** 5CP2120W, 5CP2140WCS, 5CP2150W, 5CP3120, 5CP3120G1, 5CP3130G1, 5CP5120, 5CP5150G1, 5CP6120, 5CP6120G1, 5CP6140, 5CP6150

**7CP MODELS:** 7CP6170

## INSTALLATION AND START-UP INFORMATION

Optimum performance of the pump is dependent upon the entire liquid system and will be obtained only with the proper selection, installation of plumbing, and operation of the pump and accessories.

**SPECIFICATIONS:** Maximum specifications refer to individual attributes. It is not implied that **all maximums** can be performed **simultaneously**. If more than one maximum is considered, check with your CAT PUMPS supplier to confirm the proper performance and pump selection. Refer to individual pump Data Sheet for complete specifications, parts list and exploded view.

**LUBRICATION:** Fill crankcase with special CAT PUMP oil per pump specifications (3CP-10 oz., 5CP-17 oz., 7CP-38 oz.). **DO NOT RUN PUMP WITHOUT OIL IN CRANKCASE.** Change initial fill after 50 hours running period. Thereafter, change oil every **3 months or 500 hour intervals**. Additional lubrication may be required with increased hours of operation and temperature.

**PUMP ROTATION:** Pump was designed for forward rotation to allow optimum lubrication of the crosshead area. Reverse rotation is acceptable if the crankcase oil level is increased slightly above center dot to assure adequate lubrication.

**PULLEY SELECTION:** Select size of motor pulley required to deliver the desired flow from Horsepower Requirement and Pulley Selection Chart (refer to Tech Bulletin 003 or individual Data Sheet).

**DRIVE SELECTION:** The motor or engine driving the pump must be of adequate horsepower to maintain full RPM when the pump is under load. Select the electric motor from the Horsepower Requirement Chart according to required pump discharge flow, maximum **pressure at the pump** and drive losses of approximately 3-5%. Consult the manufacturer of gas or diesel engine for selection of the proper engine size.

**MOUNTING:** Mount the pump on a rigid, horizontal surface in a manner to permit drainage of crankcase oil. An uneven mounting surface will cause extensive damage to the pump base. To minimize piping stress, **use appropriate flexible hose to inlet and discharge ports**. Use the correct belt; make sure pulleys are aligned. Excessive belt tension may be harmful to the bearings. Hand rotate pump before starting to be certain shaft and bearings are free moving.

**LOCATION:** If the pump is used in extremely dirty or humid conditions, it is recommended pump be enclosed. Do not store or operate in excessively high temperature areas or without proper ventilation.

**INLET CONDITIONS:** Refer to complete **Inlet Condition Check-List** in this manual before starting system. **DO NOT STARVE THE PUMP OR RUN DRY.** Temperatures above 130°F are permissible. Add 1/2 PSI inlet pressure per each degree F over 130°F. Elastomer or RPM changes may be required. See Tech Bulletin 002 or call CAT PUMPS for recommendations.

**C.A.T.:** Installation of a C.A.T. (Captive Acceleration Tube) is recommended in applications with stressful inlet conditions such as high temperatures, booster pump feed, long inlet lines or quick closing valves.

**DISCHARGE CONDITIONS:** **OPEN ALL VALVES BEFORE STARTING SYSTEM** to avoid deadhead overpressure condition and severe damage to the pump or system.

Install a **Pulsation Dampener** on the discharge head or in the discharge line as close to the head as possible. Be certain the pulsation dampener (Prrrrr-o-lator) is properly precharged for the system pressure (see individual Data Sheet).

A **reliable Pressure Gauge** should be installed near the discharge outlet of the high pressure manifold. This is extremely important for adjusting pressure regulating devices and also for proper sizing of the nozzle or restricting orifice. The pump is rated for a maximum pressure; this is the **pressure** which would be **read at the discharge manifold of the pump, NOT AT THE GUN OR NOZZLE.**

Use PTFE thread tape or pipe thread sealant (sparingly) to connect accessories or plumbing. Exercise caution not to wrap tape beyond the last thread to avoid tape from becoming **lodged** in the pump or accessories. This condition will cause a malfunction of the pump or system.

**PRESSURE REGULATION:** All systems require both a primary pressure regulating device (i.e., regulator, unloader) and a secondary pressure safety relief device (i.e., pop-off valve, safety valve). The primary pressure device must be installed on the discharge side of the pump. The function of the primary pressure regulating device is to protect the pump from over pressurization, which can be caused by a plugged or closed off discharge line. Over pressurization can severely damage the pump, other system components and can cause bodily harm. The secondary safety relief device must be installed **in-line** between the primary device and **the pump or on the opposite side of the manifold head**. This will ensure pressure relief of the system if the primary regulating device fails. Failure to install such a safety device will void the warranty on the pump.

When the high pressure system is left running with the trigger gun off, the by-pass liquid can be routed to drain or to the pump inlet. If routed to the pump inlet, the **by-pass liquid can quickly develop excessive heat and result in damage to the pump.** A THERMO VALVE installed in the by-pass line is recommended to protect the pump. An AUTO SHUT-OFF ASSEMBLY may also be used.

**NOZZLES:** A worn nozzle will result in loss of pressure. Do not adjust pressure regulating device to compensate. Replace nozzle and reset regulating device to system pressure.

**PUMPED LIQUIDS:** Some liquids may require a **flush between operations or before storing**. For pumping liquids other than water, contact your CAT PUMPS supplier.

**STORING:** For extended storing or between use in cold climates, drain all pumped liquids from pump and **flush with antifreeze solution to prevent freezing and damage** to the pump. **DO NOT RUN PUMP WITH FROZEN LIQUID** (refer to Tech Bulletin 083).

### WARNING

All systems require both a primary pressure regulating device (i.e., regulator, unloader) and a secondary pressure safety relief device (i.e., pop-off valve, safety valve). Failure to install such relief devices could result in personal injury or damage to the pump or to system components. CAT PUMPS does not assume any liability or responsibility for the operation of a customer's high pressure system.

### World Headquarters

CAT PUMPS

1681 - 94th Lane N.E. Minneapolis, MN 55449-4324

Phone (763) 780-5440 — FAX (763) 780-2958

e-mail: techsupport@catpumps.com

www.catpumps.com

### International Inquiries

FAX (763) 785-4329

e-mail: intlsales@catpumps.com



The Pumps with Nine Lives

### CAT PUMPS (U.K.) LTD.

1 Fleet Business Park, Sandy Lane, Church Crookham

FLEET, Hampshire, GU52 8BF, England

Phone Fleet 44 1252-622031 — Fax 44 1252-626655

e-mail: sales@catpumps.co.uk

### N.V. CAT PUMPS INTERNATIONAL S.A.

Heiveldekens 6A, B-2550 Kontich, Belgium

Phone 32-3-450.71.50 — Fax 32-3-450.71.51

e-mail: cpi@catpumps.be www.catpumps.be

### CAT PUMPS DEUTSCHLAND GmbH

Buchwiese 2, D-65510 Idstein, Germany

Phone 49 6126-9303 0 — Fax 49 6126-9303 33

e-mail: catpumps@t-online.de www.catpumps.de



**All Models**  
Removal of Valve Plugs

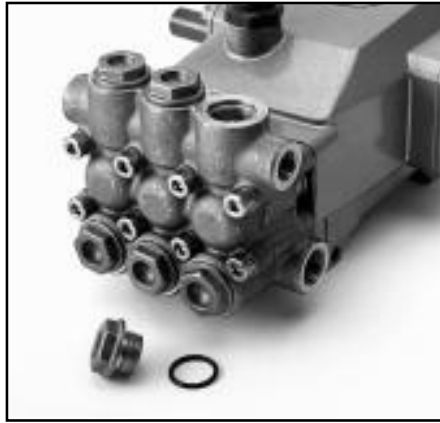

**3CP1120, 5CP2120W, 7CP6170**  
Valve Plug and O-Ring

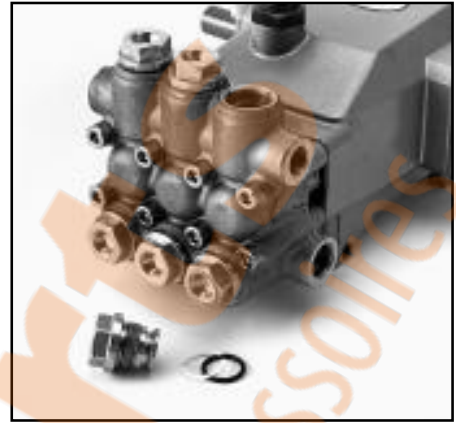

**5CP3120, 5CP5120, 5CP5150**  
Valve Plug, O-Ring and Back-up Ring

**CAUTION:** Before commencing with service, shut off drive (electric motor, gas or diesel engine) and turn off water supply to pump. Relieve all discharge line pressure by triggering gun or opening valve in discharge line.

After servicing is completed, turn on water supply to pump, start drive, reset pressure regulating device and secondary valve, read system pressure on the gauge at the pump head. Check for any leaks, vibration or pressure fluctuations and resume operation.

### SERVICING THE VALVES

1. Remove the hex Valve Plugs (top discharge, bottom inlet).
2. Examine the O-Ring under the plug for cuts or distortion. Replace if worn. Lubricate new O-Rings before installing.

**NOTE:** The 5CP3120, 5CP5120 and 5CP5150 have both an O-Ring and Back-up Ring on the Valve Plug.

3. Grasp Spring Retainer by the tab at the top with a pliers and remove from each valve chamber. Usually the valve assembly will remain together while being removed. To separate the valve assembly, insert a screw-driver into the side of the Spring Retainer and press on the back side of the Valve to begin separation, then between the Spring Retainer and Seat to separate completely. If the valve assembly separates during removal, remove the Spring and Valve with a needle nose pliers. With a reverse pliers, remove the Seat from each valve chamber. Then, with a small screwdriver, carefully remove the O-Ring at the bottom of the valve chamber.

**NOTE:** The 5CP2120W, 5CP6120 and 7CP6170 have an O-Ring and Back-up Ring on each Seat.

4. Examine all valve parts for pitting, gouges or wear and replace with preassembled Valve Assembly. Service kit contains Spring Retainers, Springs, Valves, Seats, Back-up Rings and O-Rings.

**NOTE:** Inlet and discharge valve parts are interchangeable. Two Valve Kits are needed for complete valve change.

5. Grasp new Valve Assembly by the tab at the top with a pliers, immerse in oil and push into each valve chamber. Be certain valve assembly is completely seated in valve chamber.

**NOTE:** For certain applications apply liquid gasket to the o-ring crevices and seal surfaces. See Tech Bulletin 053 for model identification.

**NOTE:** EPDM elastomers require Silicone-base lubricant.

6. Apply Loctite® 242® to the threads of each Valve Plug, thread into valve port and torque per chart.

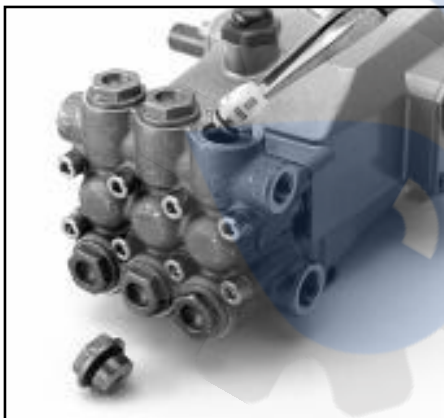

**3CP1120, 5CP2120W, 7CP6170**  
Removal of Valve Assembly



**5CP3120, 5CP5120, 5CP5150**  
Removal of Valve Assembly



**All Models**  
Removal of Valve Seat O-Ring

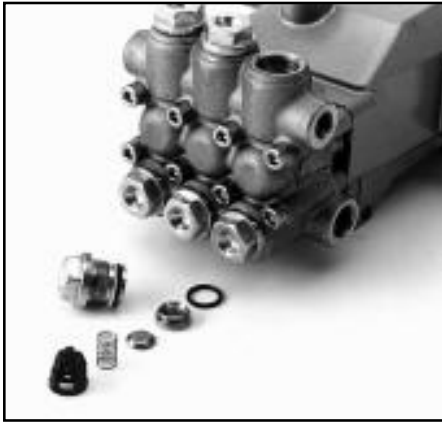

**3CP1120, 5CP3120, 5CP5120**  
Complete Valve Assembly

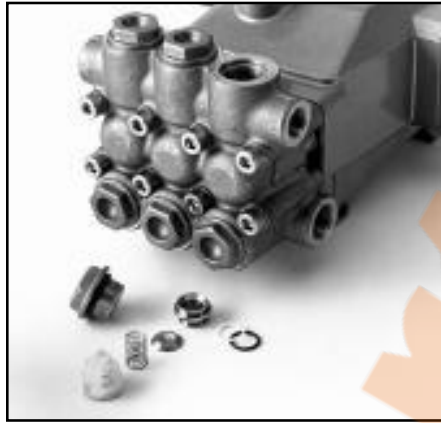

**5CP2120W, 5CP6120, 7CP6170**  
Complete Valve Assembly

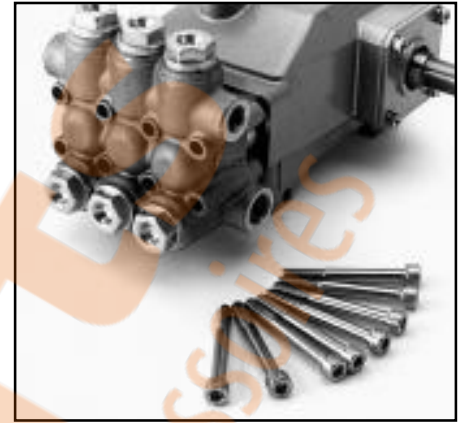

**All Models**  
Removal of Socket Head Screws

## SERVICING THE PUMPING SECTION

### Disassembly

1. Using an allen wrench, remove the Socket Head Screws from the Manifold Head.
2. Rotate Crankshaft by hand to start separation of Manifold Head from Crankcase.
3. Insert two flat head screwdrivers on opposite sides to further separate Manifold Head from Crankcase. Support the underside of the Manifold Head and tap lightly with a mallet on the backside of the Manifold Head.

**CAUTION: KEEP MANIFOLD PROPERLY ALIGNED WITH CERAMIC PLUNGERS WHEN REMOVING TO AVOID DAMAGE TO THE PLUNGERS.**

4. Remove the Seal Retainer from each plunger rod and examine for wear.
5. Examine Ceramic Plunger for cracks or scoring. Refer to **SERVICING THE PLUNGERS** if replacement is needed.

### Reassembly

1. Generally Plungers do not need to be replaced. Clean plungers and remove any foreign material with a non-abrasive cleaner.
2. Install Seal Retainer over Plungers with small tab facing down and holes facing forward towards manifold head.
3. Rotate the crankshaft so the two outside plungers are extended the same distance.
4. Lightly lubricate the Plungers and carefully slide the Manifold Head onto the Plungers supporting from the underside. On the high pressure V-Packing models or larger manifolds, it may be necessary to gently tap with a soft mallet until the Manifold Head is flush with the Crankcase.
5. Replace Socket Head Screws and torque per chart.



**3CP1120, 5CP2120W, 5CP6120**  
Seal Arrangement



**5CP3120, 5CP5120, 5CP5150, 7CP6170**  
Seal Arrangement



**All Models except 7CP6170**  
Plunger Arrangement

## SERVICING THE PLUNGERS

### Disassembly

1. To service the plungers, it is necessary to remove the manifold head. Follow disassembly procedure for **SERVICING THE PUMPING SECTION.**
2. Remove the Seal Retainer from each plunger rod.
3. Using a wrench, loosen the Plunger Retainer about three to four turns.
4. Push the Ceramic Plunger back towards the crankcase to separate from the Plunger Retainer and proceed with unthreading the Plunger Retainer by hand.
5. Remove the Plunger Retainer, Seal Washer, Ceramic Plunger, Keyhole Washer and Barrier Slinger from each Plunger Rod.
6. On the model 7CP6170 remove the Plunger Retainer, Stud, Gasket, O-Ring, Back-up Ring, Ceramic Plunger and Barrier Slinger from each Plunger Rod.
7. All other models, lubricate and install Seal Washer onto Plunger Retainer.
8. On the model 7CP6170 apply Loctite® 242® to one end of threaded Plunger Retainer Stud and secure to Plunger Retainer.
9. Examine Ceramic Plungers for scoring, scale build-up, chips or cracks and replace as needed. Generally the ceramic plungers do not need to be replaced.
10. Slide Plunger Retainer Assembly into flat end of Ceramic Plunger.
11. Apply Loctite® 242® to exposed threaded end of Plunger Retainer.
12. Install Ceramic Plunger with Plunger Retainer onto each Plunger Rod shoulder and thread Plunger Rod. Torque to specifications per chart.

**NOTE: Ceramic Plungers can only be installed in one direction. Counterbore end of Ceramic Plunger to fit over Plunger Rod shoulder.**

### Reassembly

1. Visually inspect Crankcase Oil Seals for deterioration or leaks and contact factory for assistance with replacement.
2. Replace Barrier Slinger if damaged and slide onto Plunger Rod **with concave side away from Crankcase.**
3. Examine Seal Washer for cuts or wear and replace as needed.
4. On the model 7CP6170 examine Gaskets, O-Rings and Back-up Rings for cuts or wear and replace as needed.
5. Examine Plunger Retainers and Studs for wear or damaged threads and replace as needed.
6. On the model 7CP6170 install Gaskets first, then O-Rings and Back-up Rings onto the Plunger Retainer.
13. Install Seal Retainers with small tabs facing down and holes facing forward towards manifold head.
14. Proceed with servicing the seals or remounting of Manifold Head as described.

**NOTE: Lubricate O-Rings and Back-up Rings for ease in installation and to reduce possible damage.**



## SERVICING THE SEALS AND V-PACKINGS

### Disassembly

1. Remove the Manifold Head as described in **SERVICING THE PUMPING SECTION**.
2. Place the **Crankcase side of manifold facing up** and with a reverse pliers, remove the Lo-Pressure Seal from the Seal Case.
3. Using a reverse pliers, remove the press-in style Seal Case from the Manifold Head.
4. Remove the O-Ring from O.D. of Seal Case.

### Hi-Pressure Seal

Models 3CP1120, 3CP1130, 3CP1140, 5CP2120W, 5CP2140WCS, 5CP2150W, 5CP6120, 5CP6120GI

The Hi-Pressure Seal is generally easily removed from the manifold without any tools. If extremely worn, a reverse pliers may be used.

### V-Packing

Models 5CP3120, 5CP3120G1, 5CP3130G1, 5CP5120, 5CP5150G1, 7CP6170

The V-Packings and Male Adapter are easily removed from the manifold without any tools. If extremely worn, a reverse pliers may be used.

### Reassembly

**NOTE: If your pump has been built with special seals and O-Rings, service with same type. Refer to pump Data Sheet for correct parts or kits.**

### Hi-Pressure Seal Models:

1. Lubricate each seal chamber in manifold head.  
**NOTE: For certain applications apply liquid gasket to the O-Ring crevices and seal surfaces. See Tech Bulletin 053 for model identification.**  
**NOTE: EPDM elastomers require silicone-base lubricant.**
2. Carefully square Hi-Pressure Seal into position by hand with the **grooved side down** (metal back facing out) and press into each seal chamber until completely seated.
3. Examine Seal Case O-Rings and replace if worn. Lubricate new O-Ring before installing.
4. Press the Seal Case into each seal chamber until completely seated.

### V-Packing Models:

1. Lubricate each seal chamber in manifold head.  
**NOTE: For certain applications apply liquid gasket to the O-Ring crevices and seal surfaces. See Tech Bulletin 053 for model identification.**  
**NOTE: EPDM elastomers require silicone-base lubricant.**
2. Insert Male Adapter **with notches down** and **“v” side up** and press completely into each seal chamber by hand.
3. Lubricate V-Packings and install one at a time with **grooved side down** into each seal chamber.
4. Examine Seal Case O-Ring and replace if worn. Lubricate new O-Rings before installing.
5. Press Seal Case into each seal chamber until completely seated.

### Lo-Pressure Seal-All Models:

1. Examine Lo-Pressure Seals for wear to the internal ridges, outer surfaces or for broken springs and replace as needed.
2. Install Lo-Pressure Seal into Seal Case with **garter spring down**.
3. All Models: Install Seal Retainer over Plungers with **small tabs facing down** and **holes facing forward** towards manifold head.
4. Replace Manifold Head onto pump as described under **SERVICING THE PUMPING SECTION** and torque per chart.

## SERVICING THE CRANKCASE SECTION

1. While Manifold Head, Plungers and Seal Retainers are removed, examine Crankcase Oil Seals for leaking and wear.
2. Check for any signs of leaking at Rear Cover, Drain Plug, Bubble Gauge and Dipstick (7CP6170).
3. Check oil level and for evidence of water in oil. Change crankcase oil on a regular schedule. See Preventative Maintenance Check-List.
4. Rotate Crankshaft by hand to feel for smooth bearing movement.
5. Examine Crankshaft Oil Seal externally for drying, cracking or leaking.
6. Contact CAT PUMPS or your local distributor if crankcase service is evidenced.

## PREVENTATIVE MAINTENANCE CHECK-LIST

Check	Daily	Weekly	50 hrs.	500 hrs.*	1500 hrs.**	3000 hrs.**
Clean Filters	x					
Oil Level/Quality	x					
Oil Leaks	x					
Water Leaks	x					
Belts, Pulley		x				
Plumbing		x				
Initial Oil Change			x			
Oil Change				x		
Seal Change					x	
Valve Change						x
Accessories					x	

\* If other than CAT PUMPS special custom-blend multi-viscosity ISO68 hydraulic oil is used, change cycle should be every 300 hours.

\*\* Each system's maintenance cycle will be exclusive. If system performance decreases, check immediately. If no wear at 1500 hours, check again at 2000 hours and each 500 hours until wear is observed. Valves typically require changing every other seal change.

Duty cycle, temperature, quality of pumped liquid and inlet feed conditions all effect the life of pump wear parts and service cycle.

\*\* Remember to service the regulator/unloader at each seal servicing and check all system accessories and connections before resuming operation.

Refer to service DVD for additional assistance.

## TORQUE CHART

Pump Item Pump Model	Thread	Tool Size [P/N]	Torque in. lbs. ft. lbs. Nm		
<b>Plunger Retainer</b>	M6	M10 Hex [25082]	55	4.6	6.2
<b>Manifold Screw</b>	M8	M6 Allen [30941]	115	9.58	13
<b>Valve Plugs</b>					
3CP, 5CP	M22	M24 Hex [44046]	870	72.5	98
7CP	M26	M27 Hex [44045]	870	72.5	98
<b>Bearing Cover Screws</b>					
3CP	M6	M10 Hex./Phil. [25082]	50	4.0	5.4
5CP, 7CP	M8	M13 Hex [25324]	115	9.58	13
<b>Rear Cover Screws</b>	M6	M10 Hex./Phil. [25082]	50	4.0	5.4
<b>Connecting Rod Screws</b>	M7	M10 Hex [25082]	95	8.0	11
<b>Bubble Oil Gauge</b>	M28	Oil Gauge Tool [44050]	45	3.8	5
<b>Direct Mount Bolts</b>	M8	M13 Hex [25324]	115	9.58	13

## TECHNICAL BULLETIN REFERENCE CHART

No.	Subject	Models
002	Inlet Pressure VS Liquid Temperature	All Models
003	Power Unit Drive Packages	3PFR - 68PFR, 10FR - 60FR
024	Lubrication of Lo-Pressure Seals	All Models
036	Cylinder and Plunger Reference Chart	All Models
043	LPS and HPS Servicing	All Plunger Models
060	Baffle Assembly	34170
064	By-Pass Hose Sizing	All Unloaders/Regulators
074	Torque Chart	Piston and Plunger Pumps
077	Oil Drain Kit	All Models (except 2SF/4SF)
078	Field Retrofit Mounting	5CP
083	Winterizing a Pump	All Models

## INLET CONDITION CHECK-LIST

### Review Before Start-Up

Inadequate inlet conditions can cause serious malfunctions in the best designed pump. Surprisingly, the simplest of things can cause the most severe problems or go unnoticed to the unfamiliar or untrained eye. **REVIEW THIS CHECK-LIST BEFORE OPERATION OF ANY SYSTEM.** Remember, no two systems are alike, so there can be no **ONE** best way to set-up a system. All factors must be carefully considered.

**INLET SUPPLY** should exceed the maximum flow being delivered by the pump to assure proper performance.

- Open inlet shut-off valve and turn on water supply to avoid starving pump. **DO NOT RUN PUMP DRY.**
- Temperatures above 130°F are permissible. Add 1/2 PSI inlet pressure per each degree F over 130°F. Elastomer or RPM changes may be required. See Tech Bulletin 002 or call CAT PUMPS for recommendations.
- Avoid closed loop systems especially with high temperature, ultra-high pressure or large volumes. Conditions vary with regulating/unloader valve.
- Low vapor pressure liquids, such as solvents, require a booster pump and C.A.T. to maintain adequate inlet supply.
- Higher viscosity liquids require a positive head and a C.A.T. to assure adequate inlet supply.
- Higher temperature liquids tend to vaporize and require positive heads and C.A.T. to assure adequate inlet supply.
- When using an inlet supply reservoir, size it to provide adequate liquid to accommodate the maximum output of the pump, generally a minimum of 6-10 times the GPM (however, a combination of system factors can change this requirement); provide adequate baffling in the tank to eliminate air bubbles and turbulence; install diffusers on all return lines to the tank.

**INLET LINE SIZE** should be adequate to avoid starving the pump.

- Line size must be a minimum of one size larger than the pump inlet fitting. Avoid tees, 90 degree elbows or valves in the inlet line of the pump to reduce the risk of flow restriction and cavitation.
- The line **MUST** be a FLEXIBLE hose, NOT a rigid pipe, and reinforced on SUCTION systems to avoid collapsing.
- The simpler the inlet plumbing the less the potential for problems. Keep the length to a minimum, the number of elbows and joints to a minimum (ideally no elbows) and the inlet accessories to a minimum.
- Use pipe sealant to assure air-tight, positive sealing pipe joints.

**INLET PRESSURE** should fall within the specifications of the pump.

- Acceleration loss of liquids may be increased by high RPM, high temperatures, low vapor pressures or high viscosity and may require pressurized inlet and C.A.T. to maintain adequate inlet supply. **DO NOT USE C.A.T. WITH SUCTION INLET.**
- Optimum pump performance is obtained with +20 PSI (1.4 BAR) inlet pressure and a C.A.T. for certain applications. With adequate inlet plumbing, most pumps will perform with flooded suction. Maximum inlet pressure is 60 PSI (4 BAR).
- After prolonged storage, pump should be rotated by hand and purged of air to facilitate priming. Disconnect the discharge port and allow liquid to pass through pump and measure flow.

**INLET ACCESSORIES** are offered to protect against over pressurization, contamination or temperature and control flow.

- A shut-off valve is recommended to facilitate maintenance.
- Installation of a C.A.T. is essential in applications with stressful conditions such as high temperatures, booster pump feed or long inlet lines. **Do not use C.A.T. with negative inlet pressure.**
- A stand pipe can be used in some applications to help maintain a positive head at the pump inlet line.
- Inspect and clean inlet filters on a regular schedule to avoid flow restriction.
- A pressure transducer is necessary to accurately read inlet pressure. **Short term, intermittent cavitation will not register on a standard gauge.**
- All accessories should be sized to avoid restricting the inlet flow.
- All accessories should be compatible with the solution being pumped to prevent premature failure or malfunction.
- Optional inlet protection can be achieved by installing a pressure cut off switch between the inlet filter and the pump to shut off pump when there is no positive inlet pressure.

**BY-PASS TO INLET** Care should be exercised when deciding the method of by-pass from control valves.

- It is recommended the by-pass be directed to a baffled reservoir tank, with at least one baffle between the by-pass line and the inlet line to the pump.
- Although not recommended, by-pass liquid may be returned to the inlet line of the pump if the system is properly designed to protect your pump. When a pulsation dampener is used, a **PRESSURE REDUCING VALVE** must be installed on the inlet line (**BETWEEN THE BY-PASS CONNECTION AND THE INLET TO THE PUMP**) to avoid excessive pressure to the inlet of the pump. It is also recommended that a **THERMO VALVE** be used in the by-pass line to monitor the temperature build-up in the by-pass loop to avoid premature seal failure.
- A reinforced, flexible, low pressure hose rated up to 300 PSI should be used for routing by-pass back to the pump inlet.
- Caution should be exercised not to undersize the by-pass hose diameter and length. Refer to Technical Bulletin 064 for additional information on the size and length of the by-pass line.
- Check the pressure in the by-pass line to avoid over pressurizing the inlet.
- The by-pass line should be connected to the pump inlet line at a gentle angle of 45° or less and no closer than 10 times the pump inlet port diameter e.g. 1-1/2" port size = 15" distance from pump inlet port.

## HOSE FRICTION LOSS

Water* Flow Gal/Min	PRESSURE DROP IN PSI PER 100 FT OF HOSE WITH TYPICAL WATER FLOW RATES Hose Inside Diameters, Inches						
	1/4	5/16	3/8	1/2	5/8	3/4	1"
0.5	16	5	2				
1	54	20	7	2			
2	180	60	25	6	2		
3	380	120	50	13	4	2	
4		220	90	24	7	3	
5		320	130	34	10	4	
6			220	52	16	7	1
8			300	80	25	10	2
10			450	120	38	14	3
15			900	250	80	30	7
20			1600	400	121	50	12
25				650	200	76	19
30					250	96	24
40					410	162	42
50					600	235	62
60						370	93

\*At a fixed flow rate with a given size hose, the pressure drop across a given hose length will be directly proportional. A 50 ft. hose will exhibit one-half the pressure drop of a 100 ft. hose. Above values shown are valid at all pressure levels.

## WATER LINE PRESSURE LOSS PRESSURE DROP IN PSI PER 100 FEET

Water GPM	Steel Pipe—Nominal Dia.					Brass Pipe—Nominal Dia.					Copper Tubing O.D. Type L							
	1/4	3/8	1/2	3/4	1 1/4	1 1/2	1/4	3/8	1/2	3/4	1 1/4	1 1/2	1/4	3/8	1/2	5/8	3/4	7/8
1	8.5	1.9					6.0	1.6					120	13	2.9	1.0		
2	30	7.0	2.1				20	5.6	1.8				400	45	10	3.4	1.3	
3	60	14	4.5	1.1			40	11	3.6				94	20	6.7	2.6		
5	150	36	12	2.8			100	28	9.0	2.2			230	50	17	6.1	3.0	
8	330	86	28	6.7	1.9		220	62	21	5.2	1.6		500	120	40	15	6.5	
10	520	130	43	10	3.0		320	90	30	7.8	2.4		180	56	22	10		
15	270	90	21	6.2	1.6		190	62	16	5.0	1.5		120	44	20			
25	670	240	56	16	4.2	2.0	470	150	40	12	3.8	1.7	330	110	50			
40		66	17	8.0				39	11	5.0			550	200	88			
60				37	17					23	11							
80				52	29					40	19							
100				210	107	48				61	28							

## RESISTANCE OF VALVES AND FITTINGS

Nominal Pipe Size Inches	Inside Diameter Inches	Equivalent Length of Standard Pipe in Feet								
		Gate Valve	Globe Valve	Angle Valve	45° Elbow	90° Elbow	180° Close Ret	Tee Thru Run	Tee Thru Branch	
1/2	0.622	0.41	18.5	9.3	0.78	1.67	3.71	0.93	3.33	
3/4	0.824	0.54	24.5	12.3	1.03	2.21	4.90	1.23	4.41	
1	1.049	0.69	31.2	15.6	1.31	2.81	6.25	1.56	5.62	
1 1/4	1.380	0.90	41.0	20.5	1.73	3.70	8.22	2.06	7.40	
1 1/2	1.610	1.05	48.0	24.0	2.15	4.31	9.59	2.40	8.63	
2	2.067	1.35	61.5	30.8	2.59	5.55	12.30	3.08	11.60	
2 1/2	2.469	1.62	73.5	36.8	3.09	6.61	14.70	3.68	13.20	
3	3.068	2.01	91.5	45.8	3.84	8.23	18.20	4.57	16.40	
4	4.026	2.64	120.0	60.0	5.03	10.80	23.90	6.00	21.60	

Arriving at a total line pressure loss, consideration should then be given to pressure loss created by valves, fittings and elevation of lines.

If a sufficient number of valves and fittings are incorporated in the system to materially affect the total line loss, add to the total line length, the equivalent length of line of each valve or fitting.

## TYPICAL RESERVOIR TANK RECOMMENDED 6 TO 10 TIMES SYSTEM CAPACITY

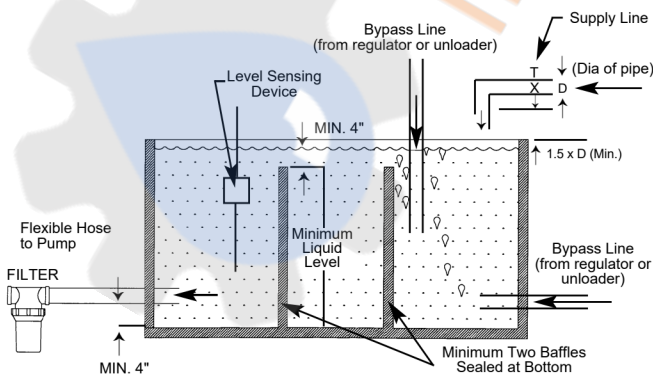

## Handy Formulas to Help You

Q. How can I find the RPM needed to get specific GPM (Gallons Per Minute) I want?

A. Desired RPM = Desired GPM x  $\frac{\text{Rated RPM}}{\text{Rated GPM}}$

Q. I have to run my pump at a certain RPM. How do I figure the GPM I'll get?

A. Desired GPM = Desired RPM x  $\frac{\text{Rated GPM}}{\text{Rated RPM}}$

Q. Is there a simple way to find the approximate horsepower I'll need to run the pump?

A. Electric Brake Horsepower Required =  $\frac{\text{GPM} \times \text{PSI}}{1460}$  (Standard 85% Mech. Efficiency)

Q. What size motor pulley should I use?

A. Pump Pulley (Outer Diameter) x  $\frac{\text{Pump RPM}}{\text{Motor/Engine RPM}}$  (Consult Engine Mfr.)

Q. How do I calculate the torque for my hydraulic drive system?

A. Torque (ft. lbs.) =  $3.6 \left( \frac{\text{GPM} \times \text{PSI}}{\text{RPM}} \right)$

## Avoid Cavitation Damage

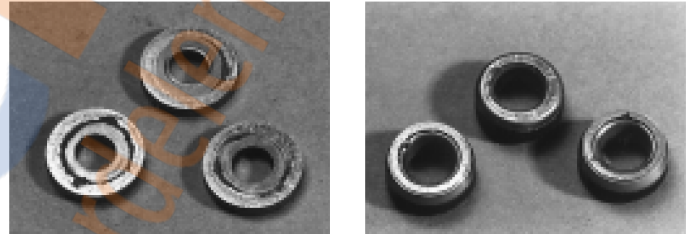

One or several of the conditions shown in the chart below may contribute to cavitation in a system resulting in premature wear, system downtime and unnecessary operating costs.

CONDITION	SOLUTION
Inadequate inlet line size	• Increase line size to the inlet port or one size larger
Water hammering liquid acceleration/ deacceleration	• Install C.A.T. Tube • Move pump closer to liquid supply
Rigid Inlet Plumbing	• Use flexible wire reinforced hose to absorb pulsation and pressure spikes
Excessive Elbows in Inlet Plumbing	• Keep elbows to a minimum and less than 90°
Excessive Liquid Temperature	• Use Thermo Valve in bypass line • Do not exceed pump temperature specifications • Substitute closed loop with baffled holding tank • Adequately size tank for frequent or high volume bypass • <b>Pressure feed high temperature liquids</b> • Properly ventilate cabinets and rooms
Air Leaks in Plumbing	• Check all connections • Use PTFE thread tape or pipe thread sealant
Agitation in Supply Tank	• Size tank according to pump output — <b>Minimum 6-10 times system GPM</b> • Baffle tank to purge air from liquid and separate inlet from discharge
High Viscosity Liquids	• Verify viscosity against pump specifications before operation • Elevate liquid temperature enough to reduce viscosity • Lower RPM of pump • Pressure feed pump • Increase inlet line size
Clogged Filters	• Perform regular maintenance or use clean filters to monitor build up • Use adequate mesh size for liquid and pump specifications

## DIAGNOSIS AND MAINTENANCE

One of the most important steps in a high pressure system is to establish a regular maintenance program. This will vary slightly with each system and is determined by various elements such as the duty cycle, the liquid being pumped, the actual specifications vs rated specifications of the pump, the ambient conditions, the inlet conditions and the accessories in the system. A careful review of the necessary inlet conditions and protection devices required before the system is installed will eliminate many potential problems.

CAT PUMPS are very easy pumps to service and require far less frequent service than most pumps. Typically, only common tools are required, making in-field service convenient, however, there are a few custom tools, special to certain models, that do simplify the process. This service manual is designed to assist you with the disassembly and reassembly of your pump. The following guide will assist in determining the cause and remedy to various operating conditions. You can also review our **FAQ** or **SERVICE** sections on our **WEB SITE** for more facts or contact CAT PUMPS directly.

PROBLEM	PROBABLE CAUSE	SOLUTION
<b>Low pressure</b>	<ul style="list-style-type: none"> <li>•Worn nozzle.</li> <li>•Belt slippage.</li> <li>•Air leak in inlet plumbing.</li> <li>•Pressure gauge inoperative or not registering accurately.</li> <li>•Relief valve stuck, partially plugged or improperly adjusted.</li> <li>•Inlet suction strainer (filter) clogged or improperly sized.</li> <li>•Abrasives in pumped liquid.</li> <li>•Leaky discharge hose.</li> <li>•Inadequate liquid supply.</li> <li>•Severe cavitation.</li> <li>•Worn seals.</li> <li>•Worn or dirty inlet/discharge valves.</li> </ul>	<ul style="list-style-type: none"> <li>•Replace with properly sized nozzle.</li> <li>•Tighten belt(s) or install new belt(s).</li> <li>•Tighten fittings and hoses. Use PTFE liquid or tape.</li> <li>•Check with new gauge. Replace worn or damaged gauge.</li> <li>•Clean/adjust relief valve. Replace worn seats/valves and o-rings.</li> <li>•Clean filter. Use adequate size filter. Check more frequently.</li> <li>•Install proper filter.</li> <li>•Replace discharge hose with proper rating for system.</li> <li>•Pressurize inlet and install C.A.T.</li> <li>•Check inlet conditions.</li> <li>•Install new seal kit. Increase frequency of service.</li> <li>•Clean inlet/discharge valves or install new valve kit.</li> </ul>
<b>Pulsation</b>	<ul style="list-style-type: none"> <li>•Faulty Pulsation Dampener.</li> <li>•Foreign material trapped in inlet/discharge valves.</li> </ul>	<ul style="list-style-type: none"> <li>•Check precharge. If low, recharge, or install a new dampener.</li> <li>•Clean inlet/discharge valves or install new valve kit.</li> </ul>
<b>Water leak</b>		
•Under the manifold	<ul style="list-style-type: none"> <li>•Worn V-Packings, Hi-Pressure or Lo-Pressure Seals.</li> <li>•Worn adapter o-rings.</li> </ul>	<ul style="list-style-type: none"> <li>•Install new seal kit. Increase frequency of service.</li> <li>•Install new o-rings.</li> </ul>
•Into the crankcase	<ul style="list-style-type: none"> <li>•Humid air condensing into water inside the crankcase.</li> <li>•Excessive wear to seals and V-Packings.</li> </ul>	<ul style="list-style-type: none"> <li>•Install oil cap protector. Change oil every 3 months or 500 hours.</li> <li>•Install new seal kit. Increase frequency of service.</li> </ul>
<b>Knocking noise</b>		
•Inlet supply	<ul style="list-style-type: none"> <li>•Inadequate inlet liquid supply.</li> </ul>	<ul style="list-style-type: none"> <li>•Check liquid supply. Increase line size, pressurize or install C.A.T.</li> </ul>
•Bearing	<ul style="list-style-type: none"> <li>•Broken or worn bearing.</li> </ul>	<ul style="list-style-type: none"> <li>•Replace bearing.</li> </ul>
•Pulley	<ul style="list-style-type: none"> <li>•Loose pulley on crankshaft</li> </ul>	<ul style="list-style-type: none"> <li>•Check key and tighten set screw.</li> </ul>
<b>Oil leak</b>		
•Crankcase oil seals.	<ul style="list-style-type: none"> <li>•Worn crankcase oil seals.</li> </ul>	<ul style="list-style-type: none"> <li>•Replace crankcase oil seals.</li> </ul>
•Crankshaft oil seals and o-rings.	<ul style="list-style-type: none"> <li>•Worn crankshaft oil seals or o-rings on bearing cover.</li> </ul>	<ul style="list-style-type: none"> <li>•Remove bearing cover and replace o-rings and/or oil seals.</li> </ul>
•Drain plug	<ul style="list-style-type: none"> <li>•Loose drain plug or worn drain plug o-ring.</li> </ul>	<ul style="list-style-type: none"> <li>•Tighten drain plug or replace o-ring.</li> </ul>
•Bubble gauge	<ul style="list-style-type: none"> <li>•Loose bubble gauge or worn bubble gauge gasket.</li> </ul>	<ul style="list-style-type: none"> <li>•Tighten bubble gauge or replace gasket.</li> </ul>
•Rear cover	<ul style="list-style-type: none"> <li>•Loose rear cover or worn rear cover o-ring.</li> </ul>	<ul style="list-style-type: none"> <li>•Tighten rear cover or replace o-ring.</li> </ul>
•Filler cap	<ul style="list-style-type: none"> <li>•Loose filler cap or excessive oil in crankcase.</li> </ul>	<ul style="list-style-type: none"> <li>•Tighten filler cap. Fill crankcase to specified capacity.</li> </ul>
<b>Pump runs extremely rough</b>		
•Inlet conditions	<ul style="list-style-type: none"> <li>•Restricted inlet or air entering the inlet plumbing</li> </ul>	<ul style="list-style-type: none"> <li>•Correct inlet size plumbing. Check for air tight seal.</li> </ul>
•Pump valves	<ul style="list-style-type: none"> <li>•Stuck inlet/discharge valves.</li> </ul>	<ul style="list-style-type: none"> <li>•Clean out foreign material or install new valve kit.</li> </ul>
•Pump seals	<ul style="list-style-type: none"> <li>•Leaking V-Packings, Hi-Pressure or Lo-Pressure seals.</li> </ul>	<ul style="list-style-type: none"> <li>•Install new seal kit. Increase frequency of service.</li> </ul>
<b>Premature seal failure</b>		
	<ul style="list-style-type: none"> <li>•Scored plungers.</li> <li>•Over pressure to inlet manifold.</li> <li>•Abrasive material in the liquid being pumped.</li> <li>•Excessive pressure and/or temperature of pumped liquid.</li> <li>•Running pump dry.</li> <li>•Starving pump of adequate liquid.</li> </ul>	<ul style="list-style-type: none"> <li>•Replace plungers.</li> <li>•Reduce inlet pressure per specifications.</li> <li>•Install proper filtration at pump inlet and clean regularly.</li> <li>•Check pressure and inlet liquid temperature.</li> <li>•DO NOT RUN PUMP WITHOUT LIQUID.</li> <li>•Increase hose one size larger than inlet port size. Pressurize and install C.A.T.</li> </ul>
	<ul style="list-style-type: none"> <li>•Eroded manifold.</li> </ul>	<ul style="list-style-type: none"> <li>•Replace manifold. Check liquid compatibility.</li> </ul>